

**WALTRON TRAILERS INC.**

Home of Aldura Trailers

Aldura Racking Parts

Prices subject to change without prior notice

Date: \_\_\_\_\_

Painted: \_\_\_\_\_

Customer: \_\_\_\_\_

Contact: \_\_\_\_\_

Galvanized: \_\_\_\_\_

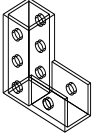
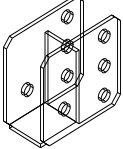
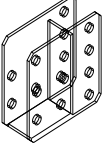
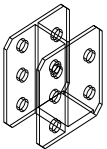
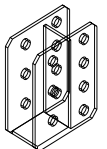
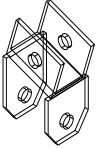
ITEM	DESCRIPTION	PAINTED		GALVANIZED		Extension
		Price (U.S. Funds)	Qty	Price (U.S. Funds)	Qty	Price
		Weight in Pounds	Painted	Weight in Pounds	Galvanized	Total Wt.- Pounds
<b>A</b>	 Coupler	\$35.57		\$39.38		
		4		4 1/4		
<b>B</b>	 Coupler	\$39.33		\$46.73		
		6		6 1/4		
<b>B-1</b>	 Double Coupler	\$62.92		\$71.47		
		10		10 1/2		
<b>B-2</b>	 Coupler	\$45.98		\$53.36		
		6		6 1/4		
<b>B-3</b>	 Coupler	\$52.03		\$59.71		
		9		9 1/2		
<b>C</b>	 Coupler	\$26.02		\$31.76		
		3 1/2		3 3/4		
				Page Total	Price	
				Page Total	Weight in lb	

**WALTRON TRAILERS INC.**

Home of Aldura Trailers

Aldura Racking Parts

Prices subject to change without prior notice

Date: \_\_\_\_\_

Painted: \_\_\_\_\_

Customer: \_\_\_\_\_

Contact: \_\_\_\_\_

Galvanized: \_\_\_\_\_

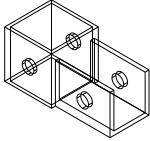
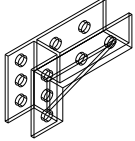
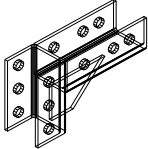
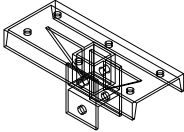
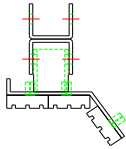
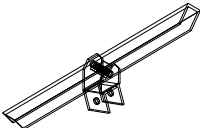
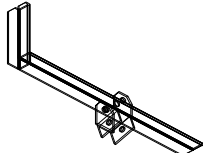
ITEM	DESCRIPTION	PAINTED		GALVANIZED		Extension
		Price (U.S. Funds)	Qty	Price (U.S. Funds)	Qty	Price
		Weight in Pounds	Painted	Weight in Pounds	Galvanized	Total Wt.- Pounds
D-1	 Coupler	\$29.86		\$34.02		
		3 1/2		3 3/4		
D-2	 Coupler	\$46.29		\$54.00		
		9 1/2		10		
D-3	 Double Coupler	\$46.29		\$54.00		
		10		10 1/2		
E	 Bow Cradle (Pad Incl.)	\$119.19		\$148.65		
		21 1/2		22 1/2		
E-1	 Bow Cradle (Pad Incl.)	\$130.68		\$160.72		
		18		19 1/2		
F	 Stern Bunk (Pad Incl.)	\$107.69		\$134.67		
		18 1/2		19 1/2		
F-2	 Stern Bunk (Pad Incl.)	\$119.79		\$142.30		
		23		24		
				Page Total		
				Page Total		

**WALTRON TRAILERS INC.**

Home of Aldura Trailers

Aldura Racking Parts

Prices subject to change without prior notice

Date: \_\_\_\_\_

Painted: \_\_\_\_\_

Customer: \_\_\_\_\_

Contact: \_\_\_\_\_

Galvanized: \_\_\_\_\_

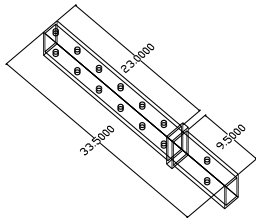
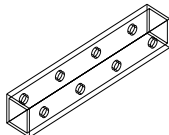
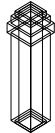
ITEM	DESCRIPTION	PAINTED			GALVANIZED		Extension	
		Price (U.S. Funds)		Qty Painted	Price (U.S. Funds)	Qty Galvanized	Price	
		Weight in Pounds			Weight in Pounds		Total Wt.- Pounds	
		Overall Length		Above Pocket				
<b>G</b>	Eg. 	24"	\$42.57	14 1/2"	\$54.00			
			12		12 1/2			
		33 1/2"	\$54.63	24"	\$62.90			
			17		18			
		43 1/2"	\$68.29	34"	\$83.54			
			24		25 1/4			
		57 1/2"	\$83.54	46"	\$105.14			
			34		35 1/4			
		63 1/2"	\$94.02	54"	\$116.89			
			38		39 3/4			
		83 1/2"	\$121.97	74"	\$153.73			
			52		54 1/4			
		97 1/2"	\$141.03	88"	\$180.42			
			62		64 3/4			
	Uprights							
<b>G-1</b>	 15 1/2" Uprights		\$30.49		\$38.12			
			9		9 1/2			
<b>G-2</b>	 Pipe		\$50.82		\$58.44			
			11		11 1/2			
						Page Total	Price	
						Page Total	Weight in lb	

**WALTRON TRAILERS INC.**

Home of Aldura Trailers

Aldura Racking Parts

Prices subject to change without prior notice







Date: \_\_\_\_\_

Painted: \_\_\_\_\_

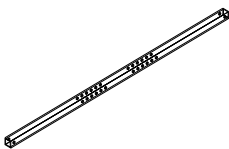
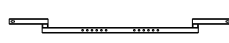
Customer: \_\_\_\_\_

Contact: \_\_\_\_\_

Galvanized: \_\_\_\_\_

ITEM	DESCRIPTION	PAINTED			GALVANIZED		Extension
		Price (U.S. Funds)		Qty Painted	Price (U.S. Funds)		Price
		Weight in Pounds			Weight in Pounds		Total Wt.- Pounds
<b>H</b>	 Crossmember	94 <sup>3</sup> / <sub>8</sub> " For 102" Width	\$125.78			\$165.17	
			60				63
		100 <sup>3</sup> / <sub>8</sub> " For 108" Width	\$137.21			\$177.87	
			64				67
		110 <sup>3</sup> / <sub>8</sub> " For 118" Width	\$151.19			\$195.66	
			70				74
<b>H-1</b>	 Offset Crossmember	94 <sup>3</sup> / <sub>8</sub> " For 102" Width	\$158.81	6 <sup>1</sup> / <sub>2</sub> " Drop		\$203.28	
		61				64 1/2	
<b>H-2</b>	 Offset Crossmember	94 <sup>3</sup> / <sub>8</sub> " For 102" Width	\$158.81	10 <sup>3</sup> / <sub>4</sub> " Drop		\$203.28	
		66				70	
<b>H-3</b>	 Offset Crossmember	100 <sup>3</sup> / <sub>8</sub> " For 108" Width	\$266.81	10 <sup>1</sup> / <sub>2</sub> " Drop		\$317.63	
		67				71	
<b>H-4</b>	 Offset Crossmember	100 <sup>3</sup> / <sub>8</sub> " For 108" Width	\$273.16	12 <sup>3</sup> / <sub>4</sub> " Drop		\$323.98	
		68				72	
<b>H-5</b>	 Offset Crossmember	110 <sup>3</sup> / <sub>8</sub> " For 118" Width	\$279.51	8 <sup>3</sup> / <sub>4</sub> " Drop		\$330.33	
		74				78 1/2	
<b>H-6</b>	 Offset Crossmember	110 <sup>3</sup> / <sub>8</sub> " For 118" Width	\$285.86	12 <sup>3</sup> / <sub>4</sub> " Drop		\$336.68	
		74				78 1/2	
						Page Total	Price
						Page Total	Weight in lb

**WALTRON TRAILERS INC.**

Home of Aldura Trailers

Aldura Racking Parts

Prices subject to change without prior notice



Date: \_\_\_\_\_

Painted: \_\_\_\_\_

Customer: \_\_\_\_\_

Contact: \_\_\_\_\_

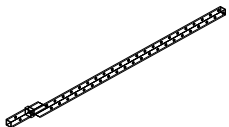
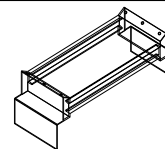
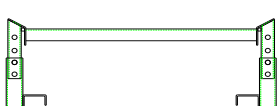
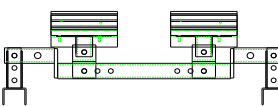
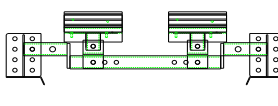
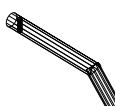
Galvanized: \_\_\_\_\_

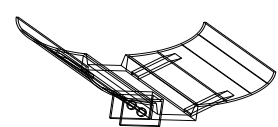
ITEM	DESCRIPTION	PAINTED		GALVANIZED		Extension	
		Price (U.S. Funds)	Qty	Price (U.S. Funds)	Qty	Price	
		Weight in Pounds	Painted	Weight in Pounds	Galvanized	Total Wt.- Pounds	
J	 93" Offset Upright	\$182.32		\$214.08			
		65		68 1/4			
K	 Pullout Saddle (Pad Incl.)	\$212.96		\$260.45			
		73		77			
K-1	 Adjustable Saddle (Pads Incl.)	\$289.04		\$326.52			
		72		76			
K-2	 Adj. Saddle Ass'y - WOB (incl E-1)	\$418.64		\$475.00			
		96		102			
K-3	 Adj. Saddle Ass'y - RGN (incl E-1)	\$418.64		\$475.00			
		96		102			
L	 5/8" Pin	N/A		\$4.96			
				1/2			
M	 Clip	\$0.61		\$0.61			
		1/8		1/8			
O	 Pontoon Saddle	\$140.36		\$160.08			
		20		21			
					Page Total	Price	
					Page Total	Weight in lb	

**WALTRON TRAILERS INC.**

Home of Aldura Trailers

Aldura Racking Parts

Prices subject to change without prior notice

Date: \_\_\_\_\_

Painted: \_\_\_\_\_

Customer: \_\_\_\_\_

Contact: \_\_\_\_\_

Galvanized: \_\_\_\_\_

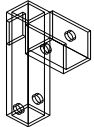
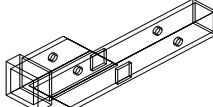
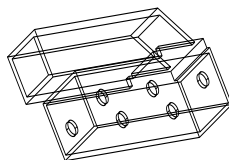
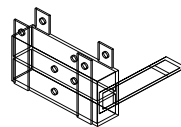
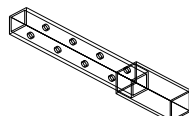
ITEM	DESCRIPTION	PAINTED		GALVANIZED		Extension
		Price (U.S. Funds)	Qty	Price (U.S. Funds)	Qty	Price
		Weight in Pounds	Painted	Weight in Pounds	Galvanized	Total Wt.- Pounds
<b>P</b>	 Stub Upright	\$38.99		\$44.76		
		7 1/2		8		
<b>U</b>	On Request Chain	On Request				
<b>V-1</b>	 Offset Upright Bracket	\$84.18		\$94.34		
		16		16 3/4		
<b>V-2</b>	 Offset Upright Bracket	3/4" Offset		\$64.48		\$74.65
				16 1/2		17 1/4
		1" Offset		\$64.48		\$74.65
				16 1/2		17 1/4
		2" Offset		\$64.48		\$74.65
				16 1/2		17 1/4
<b>V-3</b>	 Offset Upright Bracket	\$121.34		\$132.77		
		22 1/2		23 1/2		
<b>W</b>	 Upright Extension	\$49.88		\$59.48		
		16		16 3/4		
				Page Total	Price	
				Page Total	Weight in lb	

**WALTRON TRAILERS INC.**

Home of Aldura Trailers

Aldura Racking Parts

Prices subject to change without prior notice

Date: \_\_\_\_\_

Painted: \_\_\_\_\_

Customer: \_\_\_\_\_

Contact: \_\_\_\_\_

Galvanized: \_\_\_\_\_

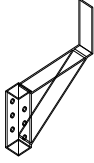
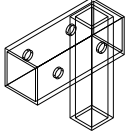
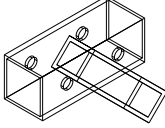
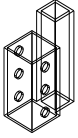
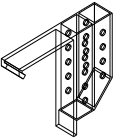
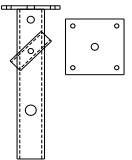
ITEM	DESCRIPTION	PAINTED		GALVANIZED		Extension
		Price (U.S. Funds)	Qty	Price (U.S. Funds)	Qty	Price
		Weight in Pounds	Painted	Weight in Pounds	Galvanized	Total Wt.- Pounds
<b>X</b>	 Mast Holder	\$49.88		\$57.50		
		13 1/2		14 1/4		
<b>Y-1</b>	 Screw Jack Holder	\$31.76		\$38.12		
		8		8 1/2		
<b>Y-2</b>	 Offset Screw Jack Holder	\$31.76		\$38.12		
		8		8 1/2		
<b>Y-3</b>	 Screw Jack Holder	\$31.76		\$38.12		
		8		8 1/2		
<b>Z-TB</b>	 Stretch Trailer Special Racking	\$261.61		\$318.77		
		50		54 1/2		
<b>Z-BB</b>	 Beacon Bracket	\$38.12		\$41.93		
		4		4 1/2		
				Page Total		
				Page Total		

# WALTRON TRAILERS INC.

Home of Aldura Trailers

Aldura Racking Parts

Prices subject to change without prior notice

Date: \_\_\_\_\_

Painted: \_\_\_\_\_

Customer: \_\_\_\_\_

Contact: \_\_\_\_\_

Galvanized: \_\_\_\_\_

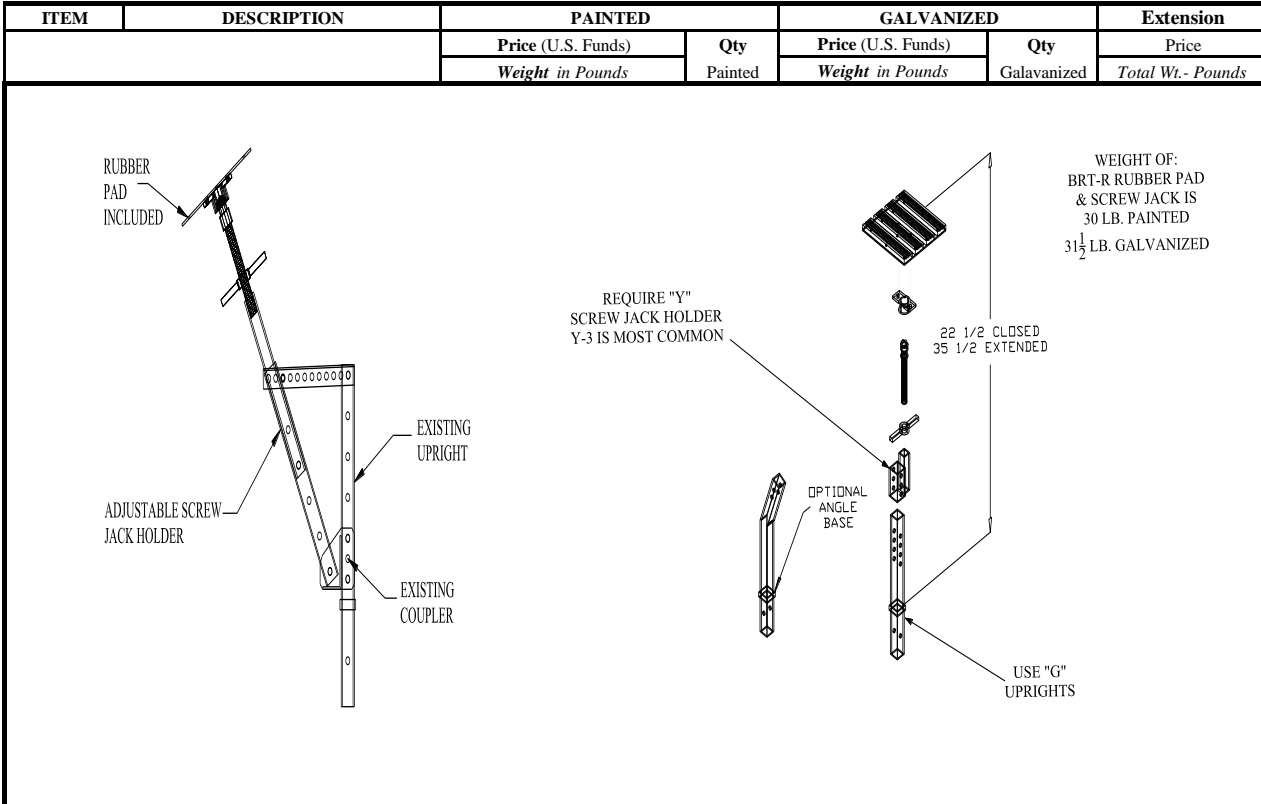

ITEM	DESCRIPTION	PAINTED		GALVANIZED		Extension
		Price (U.S. Funds)	Qty	Price (U.S. Funds)	Qty	Price
		Weight in Pounds	Painted	Weight in Pounds	Galvanized	Total Wt.- Pounds
BRT-A	Adjustable Screw Jack Holder	\$109.26		\$124.51		
		25		26 1/4		
BRT-R	15" Rubber Pad with Screw Jack incl. Knuckle	\$175.18		\$214.72		
		30		31		
BRT-R1	15" Rubber Pad with Screw Jack No Knuckle	\$148.88		\$189.45		
		30		31		
BRT-R2	10" Rubber Pad with Screw Jack Incl. Knuckle	\$139.32		\$177.06		
		28		29		
BRT-R3	10" Rubber Pad with Screw Jack No Knuckle	\$153.59		\$192.08		
		28		29		
BRT-S	Screw Jack with Knuckle	\$80.85		N/A		
		9				
BRT-S1	Screw Jack without Knuckle	\$80.96		N/A		
		6				
BRT-T	Optional Angle Base	\$60.82		\$74.33		
		25		26 1/4		
PAD-092	1" x 3" x 10" Rubber Pad	\$16.34		N/A		
		2				
PAD-093	1" x 3" x 15" Rubber Pad	\$25.30		N/A		
		2				

Page Total	Price	
Page Total	Weight in lb	



**WALTRON TRAILERS INC.**

Home of Aldura Trailers

Aldura Racking Parts

Prices subject to change without prior notice



Date: \_\_\_\_\_

Painted: \_\_\_\_\_

Customer: \_\_\_\_\_

Contact: \_\_\_\_\_

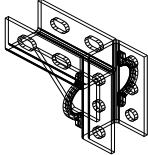
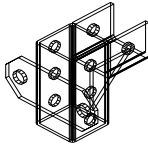
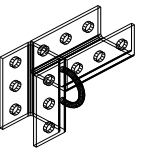
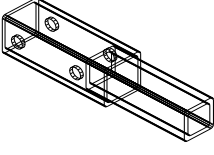
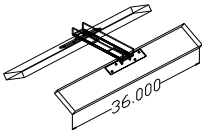
Galvanized: \_\_\_\_\_

ITEM	DESCRIPTION	PAINTED		GALVANIZED		Extension	
		Price (U.S. Funds)	Qty	Price (U.S. Funds)	Qty	Price	
		Weight in Pounds	Painted	Weight in Pounds	Galvanized	Total Wt.- Pounds	
<b>PONTOON RACKING</b>							
PT-1	 Coupler	\$56.14		\$61.71			
		8		8 1/2			
PT-2	 Coupler	\$50.82		\$55.66			
		7		7 1/2			
PT-3	 Coupler	\$50.82		\$55.66			
		6 1/2		7			
PT-4	 Extension	\$30.49		\$35.57			
		6 1/4		6 3/4			
PT-5	 Saddle	\$68.67		\$74.72			
		13 1/2		14 1/2			
PT-6	 Upright	\$163.90		\$188.03			
		50 1/4		54			
					Page Total	Price	
					Page Total	Weight in lb	

**WALTRON TRAILERS INC.**

Home of Aldura Trailers

Aldura Racking Parts

Prices subject to change without prior notice

Date: \_\_\_\_\_

Painted: \_\_\_\_\_

Customer: \_\_\_\_\_

Contact: \_\_\_\_\_

Galvanized: \_\_\_\_\_

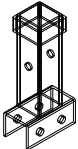
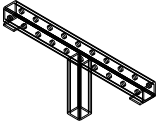
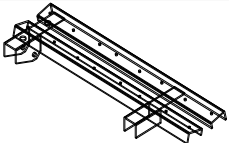
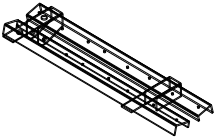
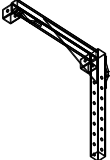
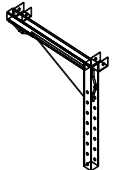
ITEM	DESCRIPTION	PAINTED		GALVANIZED		Extension	
		Price (U.S. Funds)	Qty	Price (U.S. Funds)	Qty	Price	
		Weight in Pounds	Painted	Weight in Pounds	Galvanized	Total Wt.- Pounds	
<b>PONTOON RACKING</b>							
<b>PT-7</b>	 Adjustable Pocket	\$36.21					
		10					
<b>PT-8</b>	 Adjustable Pocket Bracket	\$50.82					
		21					
<b>PT-9</b>	 Saddle - RH	\$202.98					
		40					
<b>PT-10</b>	 Saddle - LH	\$202.98					
		40					
<b>PT-11</b>	 Upright Extension - RH	\$125.46					
		44					
<b>PT-12</b>	 Upright Extension - LH	\$125.46					
		44					
					Page Total	Price	
					Page Total	Weight in lb	

**WALTRON TRAILERS INC.**

Home of Aldura Trailers

Aldura Racking Parts

Prices subject to change without prior notice



Date: \_\_\_\_\_

Painted: \_\_\_\_\_

Customer: \_\_\_\_\_

Contact: \_\_\_\_\_

Galvanized: \_\_\_\_\_

ITEM	DESCRIPTION	PAINTED		GALVANIZED		Extension
		Price (U.S. Funds)	Qty	Price (U.S. Funds)	Qty	Price
		Weight in Pounds	Painted	Weight in Pounds	Galvanized	Total Wt.- Pounds
<b>T-1</b>	 Cross Member	\$158.81		\$194.39		
		79 1/4		84		
<b>T-2</b>	 Cross Member	\$162.62		\$198.20		
		79 1/2		84		
<b>T-3</b>	 Cross Member	\$127.05		\$148.65		
		23 1/2		25		
				Page Total	Price	
				Page Total	Weight in lb	

**Note:** All Prices in U.S. Funds  
All Applicable Taxes Extra  
F.O.B Ridgeway

<b>Total Cost of Racking Pages 1 - 11</b>	Price	
<b>Total Weight of Racking Pages 1 - 11</b>	Weight in lb	